



FK Frame

Breaking capacities

Icu 400/415V AC in kA eff.

Type	V	N	H	L
FK800	50	50	80	100
FK1250	50	50	80	100
FK1600	50	50	80	

Protection

Trip Unit	Rated Current (A)	LTM	Mag Break™	SMR1e ⁽¹⁾	SMR1s ⁽¹⁾	SMR1g ⁽¹⁾
FK800	630	N, H, L				
	800	N, H, L	N, H, L	N, H, L	N, H	N, H
FK1250	1000	N, H, L		N, H, L	N, H	N, H
	1250	N, H, L	N, H, L	N, H, L	N, H	N, H
FK1600	1600			N, H	N, H	N, H

LTM

Line thermal magnetic protection

SMR1e

Selective electronic protection.

SMR1s

Selective electronic protection with enhanced functionality

SMR1g

Selective electronic protection with enhanced functionality and ground fault

Mag Break™

Magnetic only breaker for motor protection

Y

Non Automatic or switch (not mentioned in tables)

Number of poles / protected poles (trips)

3 pole 3 trips	N, H, L	N, H, L	N, H, L	N, H	N, H
4 pole 3 trips	N, H, L	N, H, L	N, H, L	N, H	N, H
4 pole 4 trips ⁽¹⁾			N, H, L	N, H	N, H

(1) Switchable, 0%, 50% or 100% neutral protection

Accessories (main types)

- ① A maximum of one Bell Alarm contact AND 3 aux. contacts (all of CO type)
- ② Shunt or Undervoltage release
- ③ Operators
Rotary handle
OR
Electrical operator
- ④ Draw out system
- ⑤ Connectors for auxiliary wiring
- ⑥ RCD with separate sensor

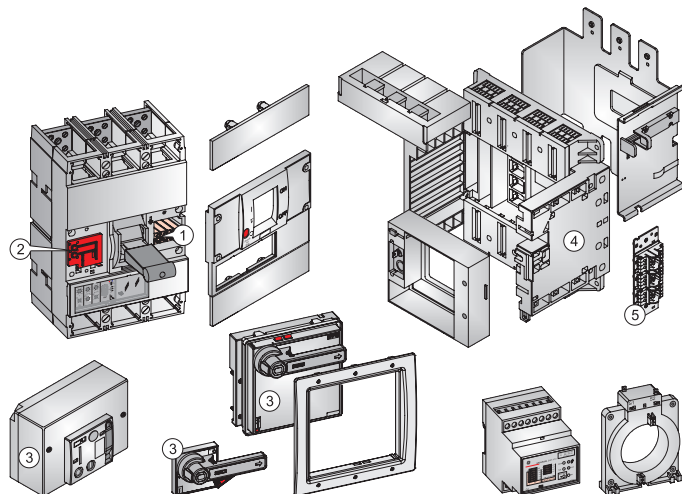

FK800 - Complete Circuit Breaker

Selective Electronic Trip Unit type SMR1e



50kA FKV	In (A)	3 pole 3 trips		4 pole ⁽¹⁾ N selectable 0-50-100%	
		Cat. nr.	Ref. nr.	Cat. nr.	Ref. nr.
	800	FKV36NE800PPF	435041	FKV46NE800PPF	435042
50kA FKN	800	FKN36NE800PPF	435393	FKN46NE800PPF	435447
80kA FKH	800	FKH36NE800PPF	435285	FKH46NE800PPF	435339
100kA FKL	800	FKL36NE800PPF	435390	FKL46NE800PPF	435282
One code covers: A standard fixed front connection breaker + Assembled trip unit + Toggle Elongator + Breaker finishing covers + Fixation hardware					

Enhanced Selective Electronic Trip Unit type SMR1s

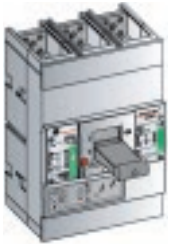

50kA FKN	In (A)	3 pole 3 trips		4 pole ⁽¹⁾ N selectable 0-50-100%	
		Cat. nr.	Ref. nr.	Cat. nr.	Ref. nr.
	800	FKN36NS800PPF	435429	FKN46NS800PPF	435483
80kA FKH	800	FKH36NS800PPF	435321	FKH46NS800PPF	435375
One code covers: A standard fixed front connection breaker + Assembled trip unit + Toggle Elongator + Breaker finishing covers + Fixation hardware					

Enhanced Selective Electronic Trip Unit type SMR1g (= s + ground fault)

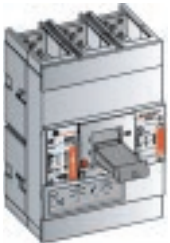

50kA FKN	In (A)	3 pole 3 trips		4 pole ⁽¹⁾ N selectable 0-50-100%	
		Cat. nr.	Ref. nr.	Cat. nr.	Ref. nr.
	800	FKN36NG800PPF	435411	FKN46NG800PPF	435465
80kA FKH	800	FKH36NG800PPF	435303	FKH46NG800PPF	435357
One code covers: A standard fixed front connection breaker + Assembled trip unit + Toggle Elongator + Breaker finishing covers + Fixation hardware					

Line Thermal magnetic trip unit LTM (adjustable settings)



50kA FKV	In (A)	3 pole 3 trips		4 pole 3 trips ⁽²⁾	
		Cat. nr.	Ref. nr.	Cat. nr.	Ref. nr.
	800	FKV36NT800PF	435005	FKV46NT800PF	435064
50kA FKN	630	FKN36NT630PF	435444	FKN436NT630PF	435408
	800	FKN36NT800PF	435336	FKN436NT800PF	435300
80kA FKH	630	FKH36NT630PF	435426	FKH436NT630PF	435462
	800	FKH36NT800PF	435318	FKH436NT800PF	435354
100kA FKL	630	FKL36NT630PF	435480	FKL436NT630PF	435534
	800	FKL36NT800PF	435372	FKL436NT800PF	435535
One code covers: A standard fixed front connection breaker + Assembled trip unit + Toggle Elongator + Breaker finishing covers + Fixation hardware					

Motor Protection (Mag Break™) Magnetic Only Breaker

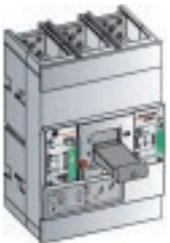

50kA FKN	In (A)	3 pole 3 trips		4 pole 3 trips ⁽²⁾	
		Cat. nr.	Ref. nr.	Cat. nr.	Ref. nr.
	800	FKN36NM800PF	435537	FKN436NM800PF	435541
80kA FKH	800	FKH36NM800PF	435538	FKH436NM800PF	435542
100kA FKL	800	FKL36NM800PF	435539	FKL436NM800PF	435543
One code covers: A standard fixed front connection breaker + Assembled trip unit + Toggle Elongator + Breaker finishing covers + Fixation hardware					

(1) Switchable 0%, 50% or 100% neutral protection, neutral on left.

(2) Neutral on left

FK1250 - Complete Circuit Breaker

Selective Electronic Trip Unit type SMR1e

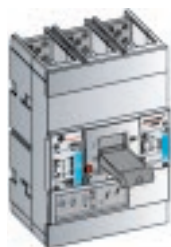

	In (A)	3 pole 3 trips		4 pole ⁽¹⁾ N selectable 0-50-100%	
		Cat. nr.	Ref. nr.	Cat. nr.	Ref. nr.
50kA FKV	1000	FKV36NE100SQF	435040	FKV46NE100SQF	435066
	1250	FKV36NE125SSF	435035	FKV46NE125SSF	435083
50kA FKN	1000	FKN36NE100SQF	435396	FKN46NE100SQF	435450
	1250	FKN36NE125SSF	435384	FKN46NE125SSF	435438
80kA FKH	1000	FKH36NE100SQF	435288	FKH46NE100SQF	435342
	1250	FKH36NE125SSF	435276	FKH46NE125SSF	435330
100kA FKL	1000	FKL36NE100SQF	435545	FKL46NE100SQF	435547
	1250	FKL36NE125SSF	435546	FKL46NE125SSF	435549
One code covers: A standard fixed front connection breaker + Assembled trip unit + Toggle Elongator + Breaker finishing covers + Fixation hardware					

Enhanced Selective Electronic Trip Unit type SMR1s

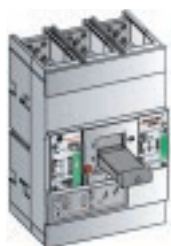

	In (A)	3 pole 3 trips		4 pole ⁽¹⁾ N selectable 0-50-100%	
		Cat. nr.	Ref. nr.	Cat. nr.	Ref. nr.
50kA FKN	1000	FKN36NS100SQF	435432	FKN46NS100SQF	435486
	1250	FKN36NS125SSF	435420	FKN46NS125SSF	435474
80kA FKH	1000	FKH36NS100SQF	435324	FKH46NS100SQF	435378
	1250	FKH36NS125SSF	435312	FKH46NS125SSF	435366
One code covers: A standard fixed front connection breaker + Assembled trip unit + Toggle Elongator + Breaker finishing covers + Fixation hardware					

Enhanced Selective Electronic Trip Unit type SMR1g (= s + ground fault)

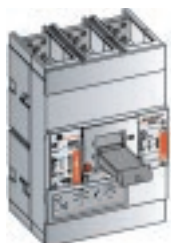

	In (A)	3 pole 3 trips		4 pole ⁽¹⁾ N selectable 0-50-100%	
		Cat. nr.	Ref. nr.	Cat. nr.	Ref. nr.
50kA FKN	1000	FKN36NG100SQF	435414	FKN46NG100SQF	435468
	1250	FKN36NG125SSF	435402	FKN46NG125SSF	435456
80kA FKH	1000	FKH36NG100SQF	435306	FKH46NG100SQF	435360
	1250	FKH36NG125SSF	435294	FKH46NG125SSF	435348
One code covers: A standard fixed front connection breaker + Assembled trip unit + Toggle Elongator + Breaker finishing covers + Fixation hardware					

Line Thermal magnetic trip unit LTM (adjustable settings)

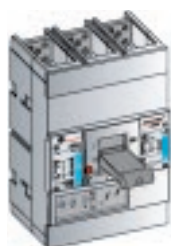

	In (A)	3 pole 3 trips		4 pole 3 trips ⁽²⁾	
		Cat. nr.	Ref. nr.	Cat. nr.	Ref. nr.
50kA FKV	1000	FKV36NT100SF	435028	FKV46NT100SF	435086
	1250	FKV36NT125SF	435030	FKV46NT125SF	435089
50kA FKN	1000	FKN36NT100SF	435550	FKN436NT100SF	435562
	1250	FKN36NT125SF	435551	FKN436NT125SF	435563
80kA FKH	1000	FKH36NT100SF	435553	FKH436NT100SF	435565
	1250	FKH36NT125SF	435554	FKH436NT125SF	435566
100kA FKL	1000	FKL36NT100SF	435555	FKL436NT100SF	435567
	1250	FKL36NT125SF	435557	FKL436NT125SF	435569
One code covers: A standard fixed front connection breaker + Assembled trip unit + Toggle Elongator + Breaker finishing covers + Fixation hardware					

Motor Protection (Mag Break™) Magnetic Only Breaker

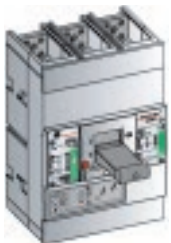

	In (A)	3 pole 3 trips		4 pole 3 trips ⁽²⁾	
		Cat. nr.	Ref. nr.	Cat. nr.	Ref. nr.
50kA FKN	1250	FKN36NM125SF	435558	FKN436NM125SF	435570
80kA FKH	1250	FKH36NM125SF	435559	FKH436NM125SF	435571
100kA FKL	1250	FKL36NM125SF	435561	FKL436NM125SF	435573
One code covers: A standard fixed front connection breaker + Assembled dummy trip unit + Toggle elongator + Breaker finishing covers + Fixation hardware					

(1) Switchable 0%, 50% or 100% neutral protection, neutral on left. (2) Neutral on left

FK1600 - Complete Circuit Breaker

Selective Electronic Trip Unit type SMR1e

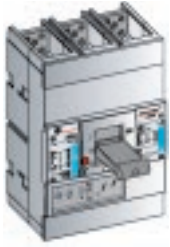

	In (A)	3 pole 3 trips		4 pole ⁽¹⁾ N selectable 0-50-100%	
		Cat. nr.	Ref. nr.	Cat. nr.	Ref. nr.
50kA FKV	1600	FKV36NE160TTF	435032	FKV46NE160TTF	4435092
	One code covers: A standard fixed front connection breaker - Assembled trip unit - fixation hardware (Electrical Operator not possible)				
50kA FKN	1600	FKN36NE160TTF	435387	FKN46NE160TTF	435441
80kA FKH	1600	FKH36NE160TTF	435279	FKH46NE160TTF	435333
One code covers: A standard fixed front connection breaker + Assembled trip unit + Toggle Elongator + Breaker finishing covers + Fixation hardware					

Enhanced Selective Electronic Trip Unit type SMR1s

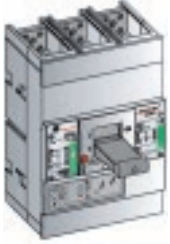

	In (A)	3 pole 3 trips		4 pole ⁽¹⁾ N selectable 0-50-100%	
		Cat. nr.	Ref. nr.	Cat. nr.	Ref. nr.
50kA FKN	1600	FKN36NS160TTF	435423	FKN46NS160TTF	435477
80kA FKH	1600	FKH36NS160TTF	435315	FKH46NS160TTF	435369
One code covers: A standard fixed front connection breaker + Assembled trip unit + Toggle Elongator + Breaker finishing covers + Fixation hardware					

Enhanced Selective Electronic Trip Unit type SMR1g (= s + ground fault)



	In (A)	3 pole 3 trips		4 pole ⁽¹⁾ N selectable 0-50-100%	
		Cat. nr.	Ref. nr.	Cat. nr.	Ref. nr.
50kA FKN	1600	FKN36NG160TTF	435405	FKN46NG160TTF	435459
80kA FKH	1600	FKH36NG160TTF	435297	FKH46NG160TTF	435351
One code covers: A standard fixed front connection breaker + Assembled trip unit + Toggle Elongator + Breaker finishing covers + Fixation hardware					

FKY- Non-Automatic Circuit Breaker (Switch)

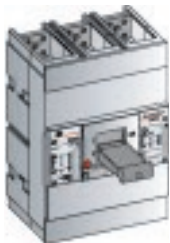

	In (A)	3 pole		4 pole ⁽²⁾	
		Cat. nr.	Ref. nr.	Cat. nr.	Ref. nr.
FKY	800	FKY306DN800PF	435495	FKY406DN800PF	435504
	1000	FKY306DN100SF	435381	FKY406DN100SF	435273
	1250	FKY306DN125SF	435489	FKY406DN125SF	435498
	1600	FKY306DN160TF	435492	FKY406DN160TF	435501
One code covers: A standard fixed front connection breaker + Assembled dummy trip unit + Toggle elongator + Breaker finishing covers + Fixation hardware					

(1) Switchable 0%, 50% or 100% neutral protection, neutral on left.

(2) Neutral on left

FK - Internal Accessories

Contacts	Changeover		Cat. nr.	Ref. nr.	Cat. nr.	Ref. nr.	Cat. nr.	Ref. nr.
	Cat. nr.	Ref. nr.						
	Aux. switch right mounted CO	FNS11R	436401					
	Bell alarm contact right mounted CO	FNBA11R	435761					

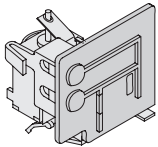
Releases	Shunt		Undervoltage		Delayed undervoltage		
	Cat. nr.	Ref. nr.	Cat. nr.	Ref. nr.	Cat. nr.	Ref. nr.	
	24V AC/DC	FNSHTD	435693	-	-	-	-
	24 V AC	-	-	FNUVR1	435698	-	-
	24 V DC	-	-	FNUVRD	435701	-	-
	48 V AC/DC	FNSHTF	435694	-	-	-	-
	48V /DC	-	-	FNUVRF	435702	-	-
	110/130V AC/DC	FNSHTJ	435695	-	-	-	-
	230V AC	-	-	FNUVR6	435699	-	-
	220/240V AC - 220/2450V DC	FNSHTN	435696	-	-	-	-
	400V AC	-	-	FNUVR8	435700	-	-
	380/440V AC/DC	FNSHT8	435692	-	-	-	-
	230V AC	-	-	-	-	FNUVD6	435697

FK - Operators

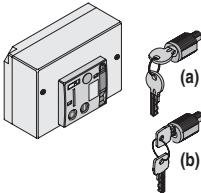
Electrical Operators	Cat. nr.	Ref. nr.		
	24V AC/DC	FNEMFD	435683	
	48V AC/DC	FNEMFF	435680	
	110V AC/DC	FNEMFJ	435686	
	230V AC/DC	FNEMFN	435689	
	Keylock for electrical operator Ronis ⁽¹⁾ (a)	FN1BRE	435679	
	Keylock for electrical operator Profalux ⁽¹⁾ (b)	FN1BPE	435678	

A

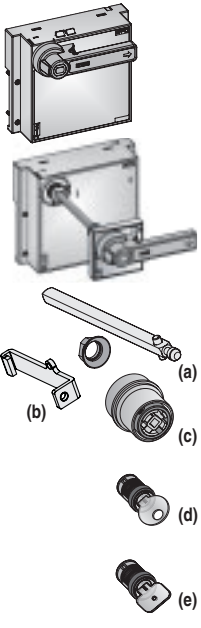
Rotary Handles	Direct on device		Rotary handle through door or cover plate ⁽²⁾		Panel or door mounted		
	Cat. nr.	Ref. nr.	Cat. nr.	Ref. nr.	Cat. nr.	Ref. nr.	
	Grey standard	FNNRF	435739	FNNRC	435726	-	-
	Red/yellow	FNNRFV	435742	FNNRCV	435729	-	-
	Grey + auxiliary contacts 2xNO ⁽³⁾	-	-	FNNRY	435748	-	-
	Red + auxiliary contacts 2xNO ⁽³⁾	-	-	FNNRYV	433431	-	-
	Grey (max. 350 mm)	-	-	-	-	FNNRD	435732
	Red (max. 350 mm)	-	-	-	-	FNNRDV	435735
	Grey + auxiliary contacts 2xNO ⁽³⁾	-	-	-	-	FNNRZ	435751
	Red + auxiliary contacts 2xNO ⁽³⁾	-	-	-	-	FNNRZV	435754
	Accessories						
	Extension shaft kit (max. 600 mm) (a)	FNNRE	435738	Only for use with panel or door mounted type			
	Flex operator adaptor push to trip (b)	FGNFT	432867	Only for use with panel or door mounted type			
Adaptor for drawout (c)	FNNRW	435745					
Ronis keylock 1104B nr. BC 1027 ⁽¹⁾ (d)	FA1BR1	430088					
Ronis keylock 1104B nr. BC 1053 ⁽¹⁾ (d)	FA1BR2	430089					
Ronis keylock 1104B nr. BC 2932 ⁽¹⁾ (d)	FA1BR3	430504					
Ronis keylock 1104B nr. BC 2911 ⁽¹⁾ (d)	FA1BR4	430505					
Ronis keylock 1104B nr. BC 2936 ⁽¹⁾ (d)	FA1BR5	430506					
Ronis keylock 1104B nr. BC 2940 ⁽¹⁾ (d)	FA1BR6	430507					
Ronis lock with random key ⁽¹⁾ (d)	FA1BRH	430068					
Profalux lock with random key ⁽¹⁾ (e)	FA1BPH	430813					

(1) Key included
 (2) Add door flange FGfH for door lock options
 (3) On request 1xNO/1xNC is available.

FK - Residual Current Devices

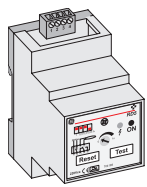

Relay

RD5

RD6

Δn	Operating voltage	Settable delay	Nr. of modules	Cat. nr.	Ref. nr.	Pack.
0.03 ... 1A	110V AC	0 - 1 s	3	RD5 110	704175	1
0.03 ... 1A	220V AC	0 - 1 s	3	RD5 220	704169	1
0.03 ... 1A	380V AC	0 - 1 s	3	RD5 380	704176	1
0.2 ... 5A	110V AC	0.5 - 5 s	3	RD6 110	704178	1
0.2 ... 5A	220V AC	0.5 - 5 s	3	RD6 220	704177	1
0.2 ... 5A	380V AC	0.5 - 5 s	3	RD6 380	704179	1

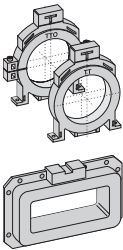

Sensor

Round Internal diameter Ø 35mm	TT 35	560091	1
Round Internal diameter Ø 60mm	TT 60	560092	1
Round Internal diameter Ø 80mm	TT 80	560093	1
Round Internal diameter Ø 110mm	TT110	560094	1
Round Internal diameter Ø 160mm	TT160	560095	1
Round Internal diameter Ø 210mm	TT 210	560096	1
Round Internal diameter Ø 22mm Din Rail type	TTD 22	560090	1
Round; splittable Internal diameter Ø 110mm	TTO 110	560097	1
Round; splittable Internal diameter Ø 210mm	TTO 210	560098	1
Rectangular opening 70 x 175mm	BTR 175	704154	1
Rectangular opening 115 x 305mm	BTR 305	704155	1
Rectangular opening 130 x 350mm	BTR 350	704156	1

FK - Drawout System

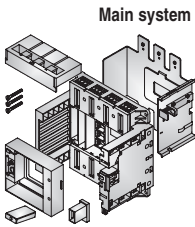

Main system

	3 pole		4 pole	
Model with front connection				
Complete set for FK800	FNWS3WP	433434	FNWS4WP	436481
Complete set for FK1250 & FK1600	FNWS3WT	436482	FNWS4WT	433442
Model with rear connection				
Complete set for FK800	FNWS3AP	433436	FNWS4AP	433440
Complete set for FK1250 & FK1600	FNWS3AT	435757	FNWS4AT	435759
One code covers the fixed and withdrawable part of the draw-out system, with plug-in base, mounting accessories and fixation hardware.				

Auxiliary disconnects
(Secondary wiring)



Complete set 6 pole	FNPFFM	435758		
---------------------	--------	--------	--	--

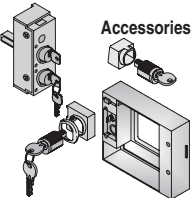

Accessories

Keylock in chasis pos. 1 Ronis 1104A ⁽¹⁾	FN1BRW1	435755		
Keylock in chasis pos. 2 Ronis 1104A ⁽¹⁾	FN1BRW2	435757		
Position indication contact CO	FNS11L	435760		
Doorflange specific for drawout type	FNFW	435758		
Keylock in doorflange pos. 1 Ronis 1104A ⁽¹⁾	FN1BRY1	433415		
Keylock in doorflange pos. 2 Ronis 1104A ⁽¹⁾	FN1BRY2	435574		

FK - Connections: Optional

Terminal Extenders⁽²⁾



	3 pcs		4 pcs	
Flat FK800 - FK1250	FNBES3P	435706	FNBES4P	435707
Flat FK1250 -FK 1600	FNBES3R	433420	FNBES4R	433422

Terminal Spreader flat⁽²⁾

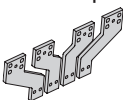

Flat FK800 - FK1250	FNBS3P	435708	FNBS4P	435711
Flat FK1250 -FK 1600	FNBS3R	435710	FNBS4R	435712

Rear Connections⁽²⁾

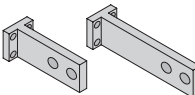

Set 3 pole (2 short, 1 long)	FNBR3	433423	-	-
Set 4 pole (2 short, 2 long)	-	-	FNBR4	433425
Set 3 pole (3 short)	FNBRCS3	433426	-	-
Set 4 pole (4 short)	-	-	FNBRCS4	433427

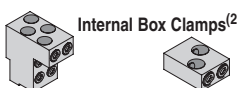



Internal Box Clamps⁽²⁾

Box Clamp Cu/Al, for 2 x 70-240 sq.mm.	FNTCA2327	433424	FNTCA2427	433437
Box Clamp Cu/Al, for 4 x 70-240 sq.mm.	FNTCA4327	433438	FNTCA4427	433439

(1) Key included
(2) Set for equipping the line OR load side of breaker.

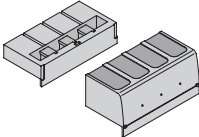
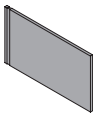

FK - Installation Accessories

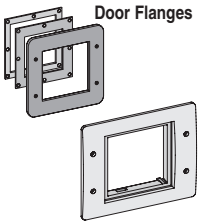
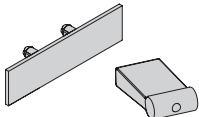
		3 pole		4 pole	
		Cat. nr.	Ref. nr.	Cat. nr.	Ref. nr.
Terminal shields (with finishing covers) 	Long, set of 2 pcs.	FNJL3	435716	FNJL4	435719
Specific to connection area 	Phase separators, set of 12 pcs	FNJP	435722		
Padlocking devices for toggle operator⁽¹⁾ 	Padlocking removable	FN1PR	433417		
Circuit indication / coding 	Set of 20 blank labels	FAC	430821		
Door Flanges 	Front face toggle area	FNFT	435715		
	Rotary handle (through cover plate model)	FNFH	435714		
	Motor operator	FNFE	435713		
Spare parts 	Finishing covers, set of 2 pcs.	FNUA3	435762	FNUA4	435763
	Spare toggle (set of 5 pieces)	FNUT	435764		

FK - Accessories Electronic Trip Units

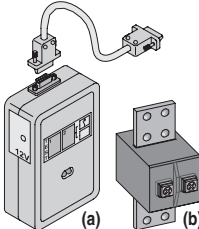
	Battery test device (a)	FNT	435704		
	Sensor 800A for Ground fault device (b)	FNGS0800	433419		
	Sensor 1000A for Ground fault device (b)	FNGS1000	433421		
	Sensor 1250A for Ground fault device (b)	FNGS1250	435709		

(1) Padlocks not included